

Bases DOMI para bisagras de enganche rápido clip.
Regulación **frontal y vertical** mediante excéntrica.

- Para bisagras Serie 100, 200, B y Silentia+.
- Taladro 21+32mm.

Base DOMI recta modelo **BAP3M**



Tornillo rosca madera

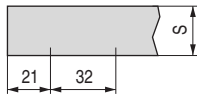



CÓDIGO	REFERENCIA	Altura	Material	Acabado	
30.539	BAP3M09	H0	acero	níquel	300
30.540	BAP3M29	H2	acero	níquel	300
30.541	BAP3M39	H3	acero	níquel	300

Base DOMI recta modelo **BAP7M**

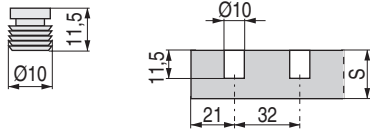

Taco montaje directo Ø10x11,5mm.



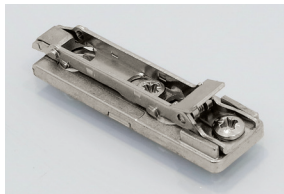

CÓDIGO	REFERENCIA	Altura	Material	Acabado	
30.536	BAP7M09	H0	acero	níquel	300
30.537	BAP7M29	H2	acero	níquel	300
30.538	BAP7M39	H3	acero	níquel	300

Base DOMI recta modelo **BAP3R**

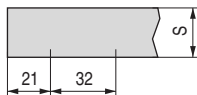

Tornillo rosca madera



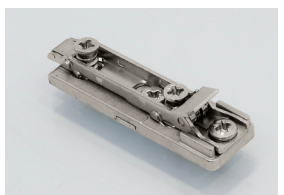

CÓDIGO	REFERENCIA	Altura	Material	Acabado	
30.501	BAP3R09	H0	zamak	níquel	300
30.502	BAP3R39	H3	zamak	níquel	300

Base DOMI recta modelo **BAPGR**

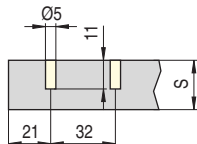

Tornillo Euro premontado Ø5x11mm.



CÓDIGO	REFERENCIA	Altura	Material	Acabado	
30.564	BAPGR09/16	H0	zamak	níquel	300
30.565	BAPGR39/16	H3	zamak	níquel	300

Base DOMI recta modelo **BAP7R**

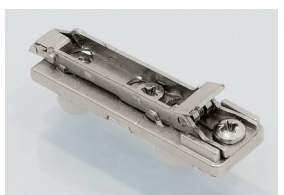

Taco montaje directo Ø10x11,5mm.

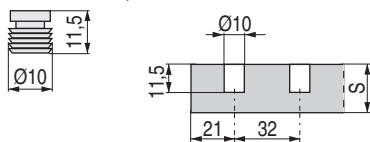

CÓDIGO	REFERENCIA	Altura	Material	Acabado	
30.567	BAP7R39	H3	zamak	níquel	300

Bases DOMI para bisagras de enganche rápido clip.
Regulación **frontal y vertical** mediante excéntrica.

- Para bisagras Serie 100, 200, B y Silentia+.
- Taladro 37x32mm.

Base DOMI avión modelo **BAR3R**

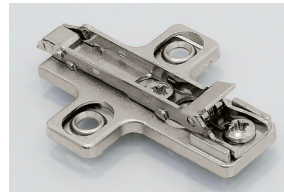

Tornillo rosca madera

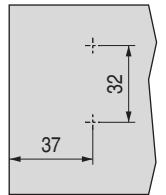

CÓDIGO	REFERENCIA	Altura	Material	Acabado	
30.506	BAR3R09	H0	zamak	níquel	300
30.507	BAR3R39	H3	zamak	níquel	300
30.508	BAR3R69	H6	zamak	níquel	300
30.509	BAR3R99	H9	zamak	níquel	300

Base DOMI avión modelo **BAR3L**



Tornillo rosca madera

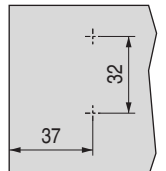

CÓDIGO	REFERENCIA	Altura	Material	Acabado	
30.129	BAR3L09F	H0	acero	níquel	300

Base DOMI avión modelo **BARGR**

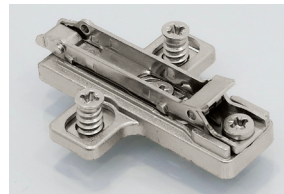

Tornillo Euro premontado Ø5x11mm.

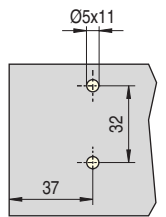

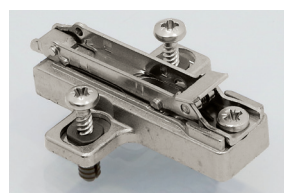

CÓDIGO	REFERENCIA	Altura	Material	Acabado	
30.217	BARGR39/16	H3	zamak	níquel	300

Base DOMI avión modelo **BAR4R**

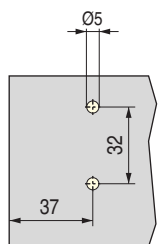

Taco Montaje directo premontado Ø5 x 11mm.



CÓDIGO	REFERENCIA	Altura	Material	Acabado	
30.512	BAR4R09/16	H0	zamak	níquel	300
30.513	BAR4R39/16	H3	zamak	níquel	300
30.514	BAR4R69/16	H6	zamak	níquel	300

Base DOMI avión modelo **BAR7R**

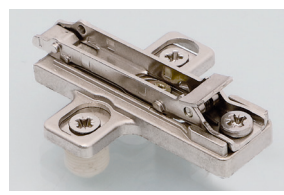

Taco montaje directo Ø10x11,5mm.



CÓDIGO	REFERENCIA	Altura	Material	Acabado	
30.515	BAR7R39	H3	zamak	níquel	300

Bases DOMI para bisagras de enganche rápido clip.
Regulación **frontal** mediante excéntrica.

- Para bisagras Serie 100, 200, B y Silentia+.
- Taladro 37x32mm.

Base DOMI avión modelo **BAV3M**



CÓDIGO	REFERENCIA	Altura	Material	Acabado	
30.546	BAV3M09F	H0	acero	níquel	300
30.547	BAV3M39F	H3	acero	níquel	300

Base DOMI avión modelo **BAV4M**

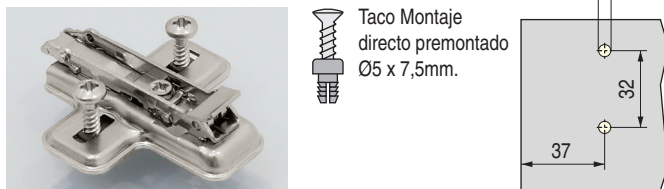

CÓDIGO	REFERENCIA	Altura	Material	Acabado	
30.549	BAV4M39F/16	H3	acero	níquel	300

Base DOMI avión modelo **BAV7M**



• Códigos con letra **V** se piden por encargo.

CÓDIGO	REFERENCIA	Altura	Material	Acabado	
30.556 V	BAV7M09F	H0	acero	níquel	300
30.557	BAV7M39F	H3	acero	níquel	300

Bases DOMI para bisagras de enganche rápido clip.
Regulación **frontal** mediante excéntrica.

- Para bisagras Serie 100, 200, B y Silentia+.
- Taladro 37x32mm.

Base tradicional avión modelo **B2VG**

Especialmente indicada para colocar en las bisagras mod. Raiza, apertura 270° para puertas embutidas.



CÓDIGO	REFERENCIA	Altura	Material	Acabado	
30.560	B2VGBV9/16	H18	zamak	níquel	300

Bases tradicionales **simétricas** para bisagras.
Regulación **vertical** ± 2mm.

- Para bisagras Serie 100, 200, B y Silentia+.
- Taladro 37x32mm.

• Las bases con valor negativo se pueden utilizar únicamente en bisagras de codo D, G y P.

Base tradicional avión modelo **B2V3**



CÓDIGO	REFERENCIA	Altura	Material	Acabado	
30.525	B2V3HS9/15	H - 2	acero	níquel	600
30.526	B2V3H09/15	H0	acero	níquel	600
30.527	B2V3H39/15	H3	acero	níquel	600
30.528	B2V3H69/15	H6	acero	níquel	600
30.529	B2V3H99/15	H9	acero	níquel	600

Base tradicional avión modelo **B2V7**



• Códigos con letra **V** se piden por encargo.

CÓDIGO	REFERENCIA	Altura	Material	Acabado	
30.531	B2V7H09/15	H0	acero	níquel	600
30.532	B2V7H39/15	H3	acero	níquel	600
30.533 V	B2V7H69/15	H6	acero	níquel	600

Bases tradicionales **asimétricas** para bisagras.
Regulación **vertical** ± 2mm.

- Para bisagras Serie 100, 200, B y Silentia+.
- Taladro 28x32mm.

Base tradicional avión modelo **B2S3B**



CÓDIGO	REFERENCIA	Altura	Material	Acabado	
30.134	B2S3B69/15	H6	zamak	níquel	600
30.128	B2S3B99B6	H9	zamak	níquel	600

Base tradicional avión modelo **B2S3**



CÓDIGO	REFERENCIA	Altura	Material	Acabado	
30.248	B2S3H09/15	H0	acero	níquel	600

Bases tradicionales inclinadas para bisagras.
Regulación **vertical** $\pm 2\text{mm}$.

- Para bisagras Serie 200 de ángulo especial
- Válidas para montajes especiales y posiciones intermedias. En combinación con los diversos codos de las bisagras, ofrecen innumerables soluciones de montajes angulares para las puertas.

Base ESPECIAL INCLINADA 15° avión modelo B2V3

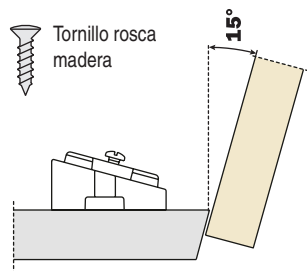

CÓDIGO	REFERENCIA	Altura	Material	Acabado	
30.561	B2V3BW9/15	15°	zamak	níquel	600

Base ESPECIAL INCLINADA +7,5° avión modelo B2V3

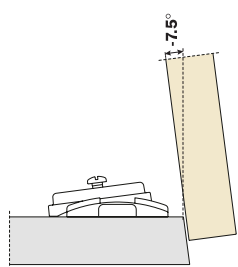
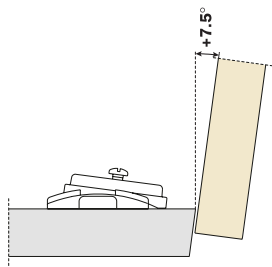
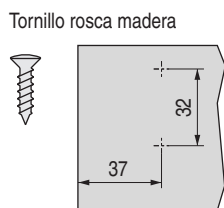

CÓDIGO	REFERENCIA	Altura	Material	Acabado	
30.562	B2V3BW9R/15	-7,5° / +7,5°	zamak	níquel	600

Base ESPECIAL INCLINADA +10°/+30° avión modelo B2V3

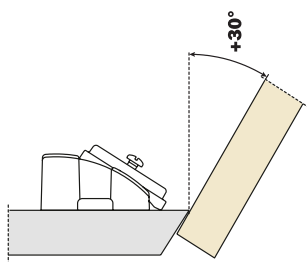
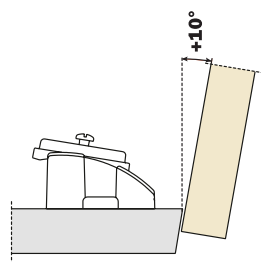
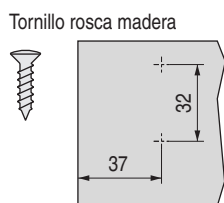

CÓDIGO	REFERENCIA	Altura	Material	Acabado	
30.563	B2V3BW9S/15	+10° / +30°	zamak	níquel	300

Ejemplos de montajes con ángulos especiales:
La distancia de taladro de las bases inclinables varían al variar el ángulo de utilización.

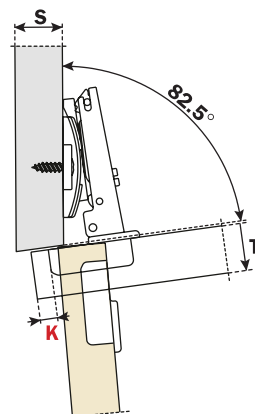

CON BASE 30.562

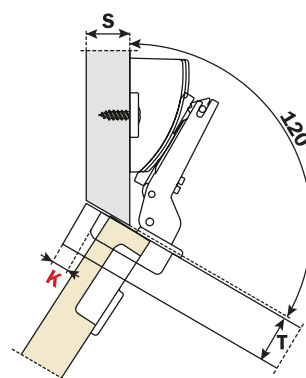
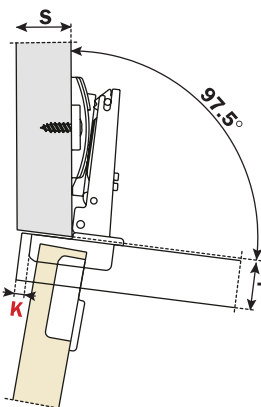

CON BASE 30.563

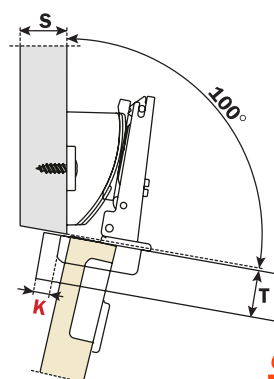

Tapa cubrecazoleta para bisagras SALICE



- Cubrecazoleta de acero níquelado.
- Válido para todas las bisagras SALICE serie 100, 200, 700 y Silentia+.

CÓDIGO	REFERENCIA	Material	Acabado	
30.120	S2XX85H9	acero	níquel	3.000

Tapa cubrebrazo para bisagras SALICE



- Cubrebrazo simétrico de acero níquelado.
- Válido para todas las bisagras SALICE serie 100, 200, 700 y B.

CÓDIGO	REFERENCIA	Material	Acabado	
30.124	S2BX83H9	acero	níquel	3.000

Topo de apertura para bisagras de 94° SALICE



- Limita la apertura de la bisagra a 86°.
- Válido para todas las bisagras SALICE con apertura 94° y cazoleta de 35mm.

CÓDIGO	REFERENCIA	Material	Acabado	
30.29	S2A637XF	hierro	zincado	500

SUPLEMENTO 1,8mm. para bisagras SALICE

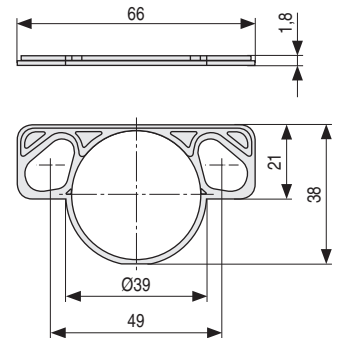

- Válido para reducir la profundidad de taladro en bisagras de apertura 94° y 110°.

CÓDIGO	REFERENCIA	Material	Acabado	
30.18	S2XX86KT	plástico	transparente	1.200

Broca Ø35,5 especial para bisagras

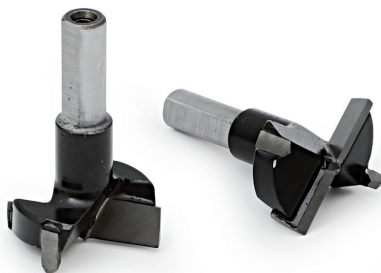

- Broca especial de metal duro.
- Válida para cualquier bisagra del mercado con cazoleta de 35mm.
- Códigos con letra V se piden por encargo.

CÓDIGO	Material	Acabado	
30.21V	acero	negro	1

Broca Ø35 universal para bisagras



- Broca especial de metal duro.
- Válida para cualquier bisagra del mercado con cazoleta de 35mm.

CÓDIGO	Mano	Material	
301.486	derecha	acero	1
301.487	izquierda	acero	1